

PRODOTTI / RICAMBI  
PRODUCTS / SPARE PARTS  
PRODUITS / PIÈCES DÉTACHÉES  
PRODUKTE / ERSATZTEILE  
PRODUCTOS / REPUESTOS

*Appia*  
MADE IN ITALY

Esplosi: mod. " 2-3 GR "

28-11-2008

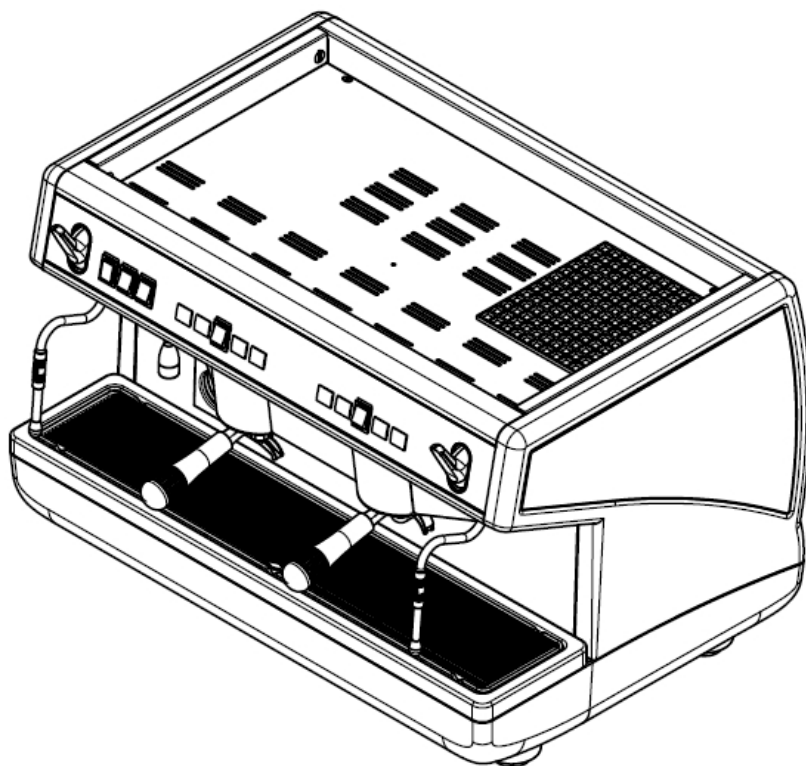

 nuova  
**SIMONELLI**®

# I N D I C E

- » TAV □1 - **COMPONENTI GRUPPO CARENA**  
CABINET PARTS
- » TAV □2 - **COMPONENTI GRUPPO INVOLUCRO COMANDI**  
CONTROL PANEL PARTS
- » TAV □4 - **COMPONENTI GRUPPO EROGAZIONE**  
POURING UNIT GROUP PARTS
- » TAV □5 - **COMPONENTI IDRAULICI 2 GRUPPI**  
HYDRAULIC PARTS 2 GROUPS
- » TAV □5 - **COMPONENTI IDRAULICI 3 GRUPPI**  
**BIS** HYDRAULIC PARTS 3 GROUPS
- » TAV □6 - **COMPONENTI RUBINETTI VAPORE E ACQUA CALDA**  
STEAM & HOT WATER VALVES PARTS
- » TAV □8 - **COMPONENTI GRUPPO IDRAULICO**  
HYDRAULIC GROUP PARTS
- » TAV □9 - **COMPONENTI CALDAIA**  
BOILER PARTS
- » TAV 1 □ - **COMPONENTI TELAIO**  
FRAME PARTS
- » TAV 1 1 - **COMPONENTI ELETTRICI ED ELETTRONICI**  
ELECTRONIC & ELECTRIC PARTS

## » LEGENDA :

I CODICI SCRITTI IN GRASSETTO SI RIFERISCONO AI COMPONENTI IMPIEGATI ATTUALMENTE.

I CODICI IMPIEGATI PRIMA SONO SCRITTI IN CORSIVO CON INDICATA A FIANCO LA DATA DI FINE VALIDITA'.

ESEMPIO:

*07300127 (φ2.5) - 18/09/2007*  
**07300226 (φ2)**

# COMPONENTI GRUPPO CARENA

## CABINET PARTS

A  
P  
P  
I  
A

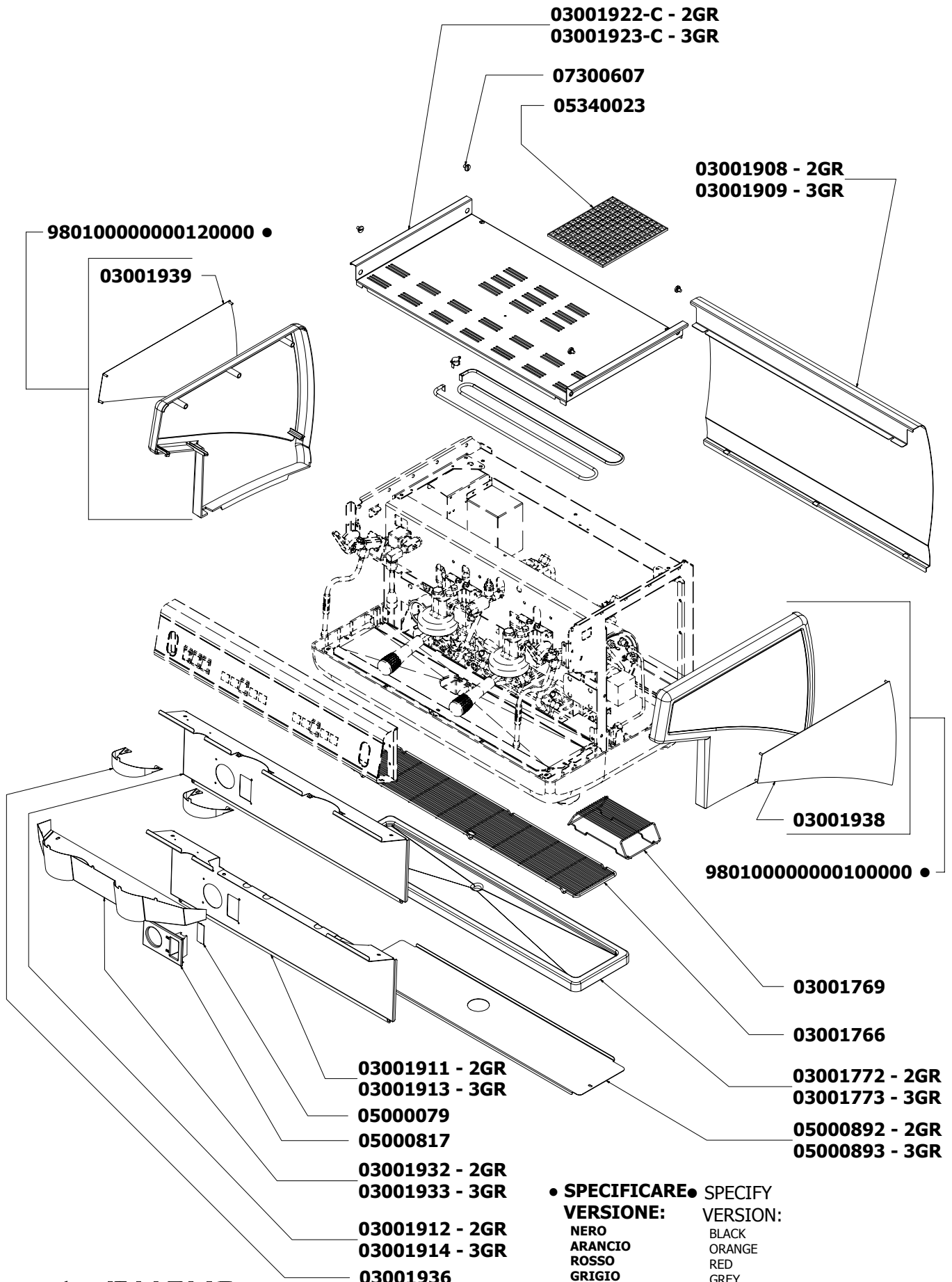

● **SPECIFICARE** ● SPECIFY  
**VERSIONE:** VERSION:  
 NERO BLACK  
 ARANCIO ORANGE  
 ROSSO RED  
 GRIGIO GREY  
 INOX-NERO INOX-BLACK  
 INOX-ARANCIO INOX-ORANGE  
 INOX-ROSSO INOX-RED  
 INOX-GRIGIO INOX-GREY

# COMPONENTI GRUPPO INVOLUCRO COMANDI CONTROL PANEL PARTS

A  
P  
P  
I  
A

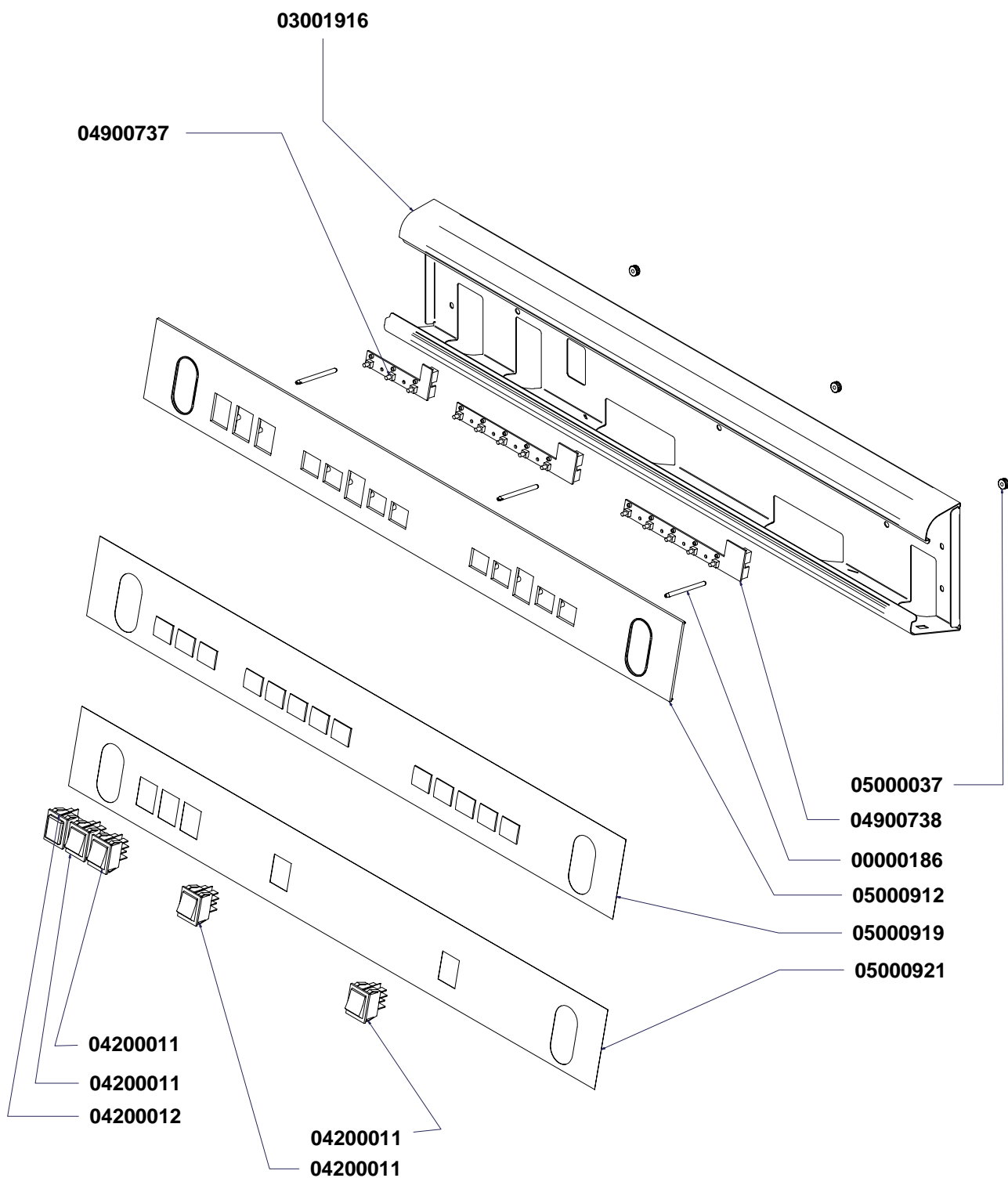

# COMPONENTI GRUPPO EROGAZIONE

## POURING UNIT GROUP PARTS

A  
P  
P  
I  
A

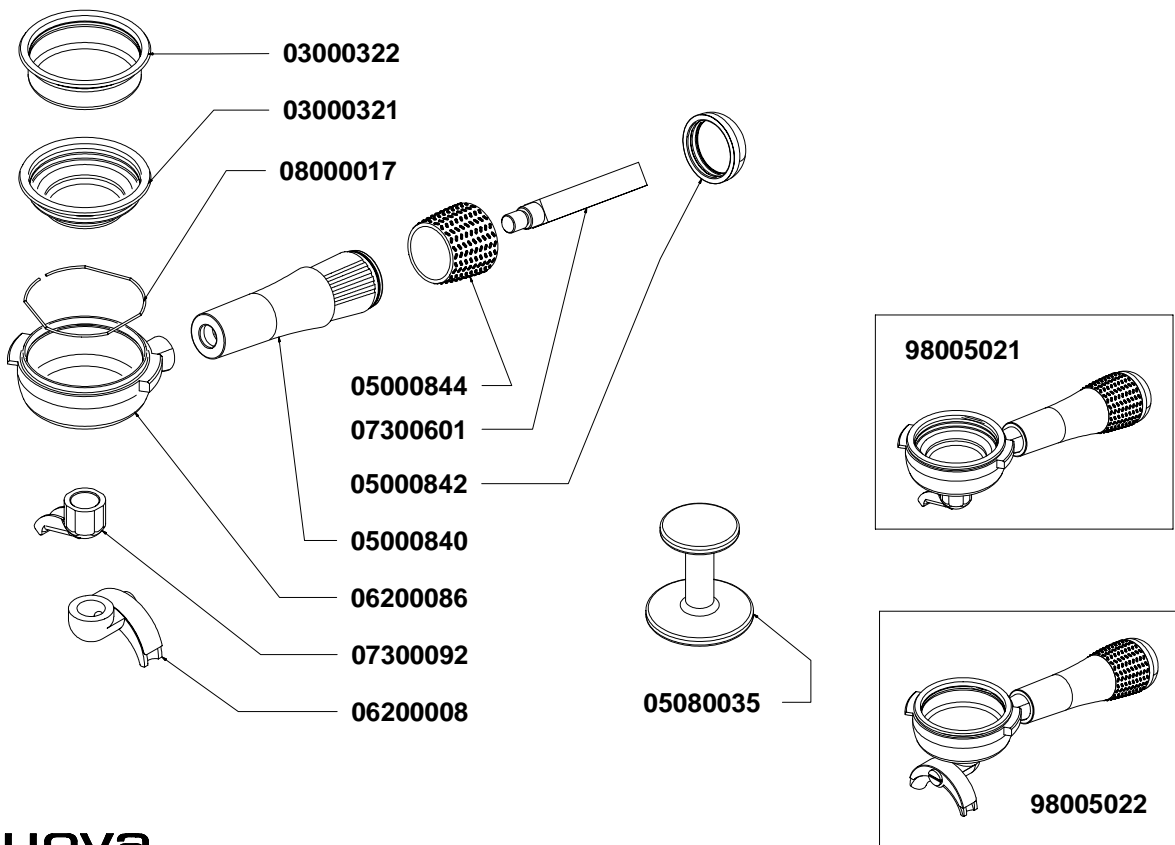
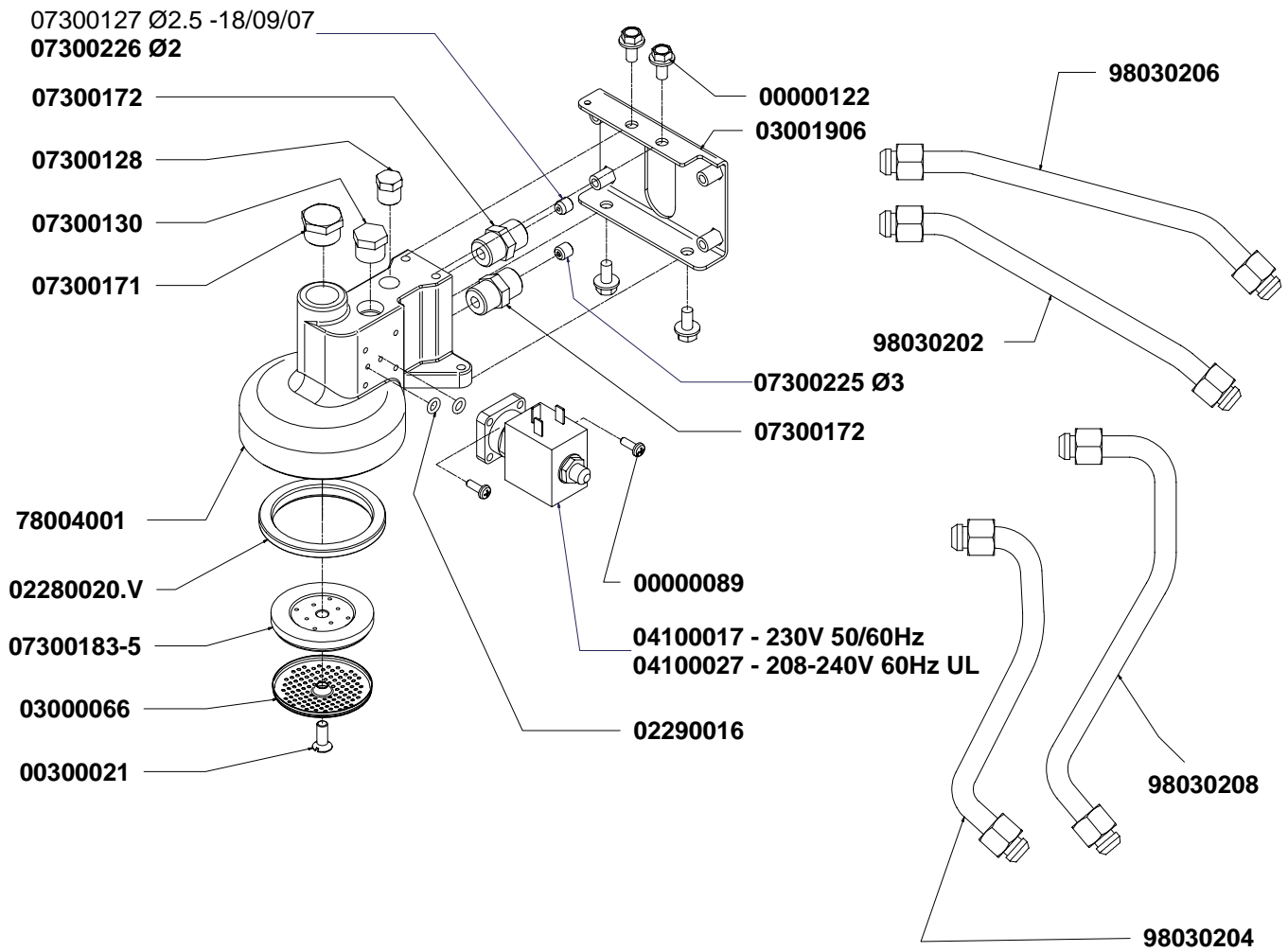

# COMPONENTI IDRAULICI 2 GRUPPI HYDRAULIC PARTS 2 GROUPS

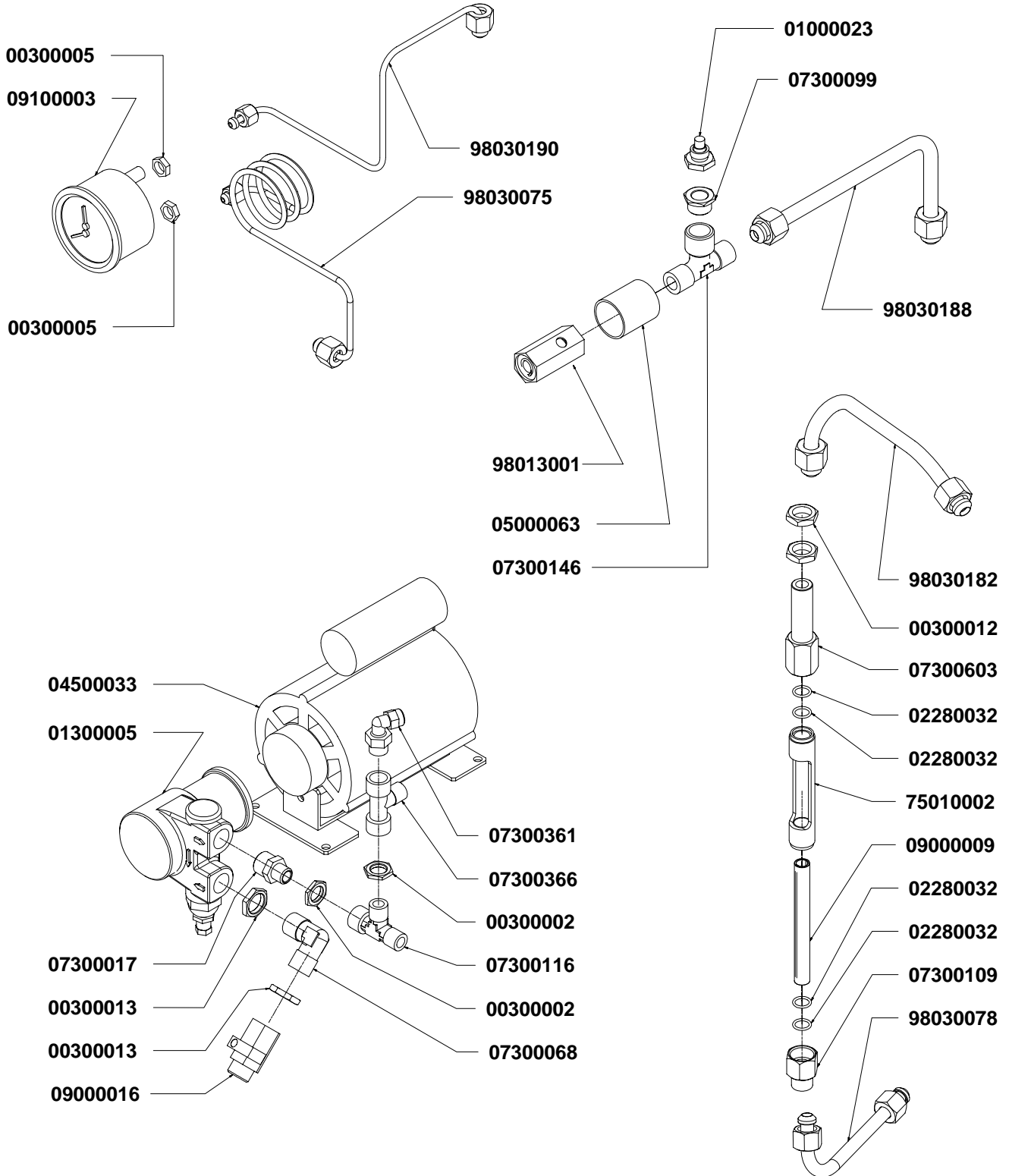

COMPONENTI IDRAULICI		
CODICE	DESCRIZIONE	DESCRIPTION
01000113	TUBO INGRESSO L=1500	FILLING TUBE L=1500
01000030	TUBO INGRESSO L=500	FILLING TUBE L=500
01000087	TUBO SCARICO	DRAINING TUBE
00000133	FASCETTA INOX	STAINLESS GIRDLE

# COMPONENTI IDRAULICI 3 GRUPPI

## HYDRAULIC PARTS 3 GROUPS

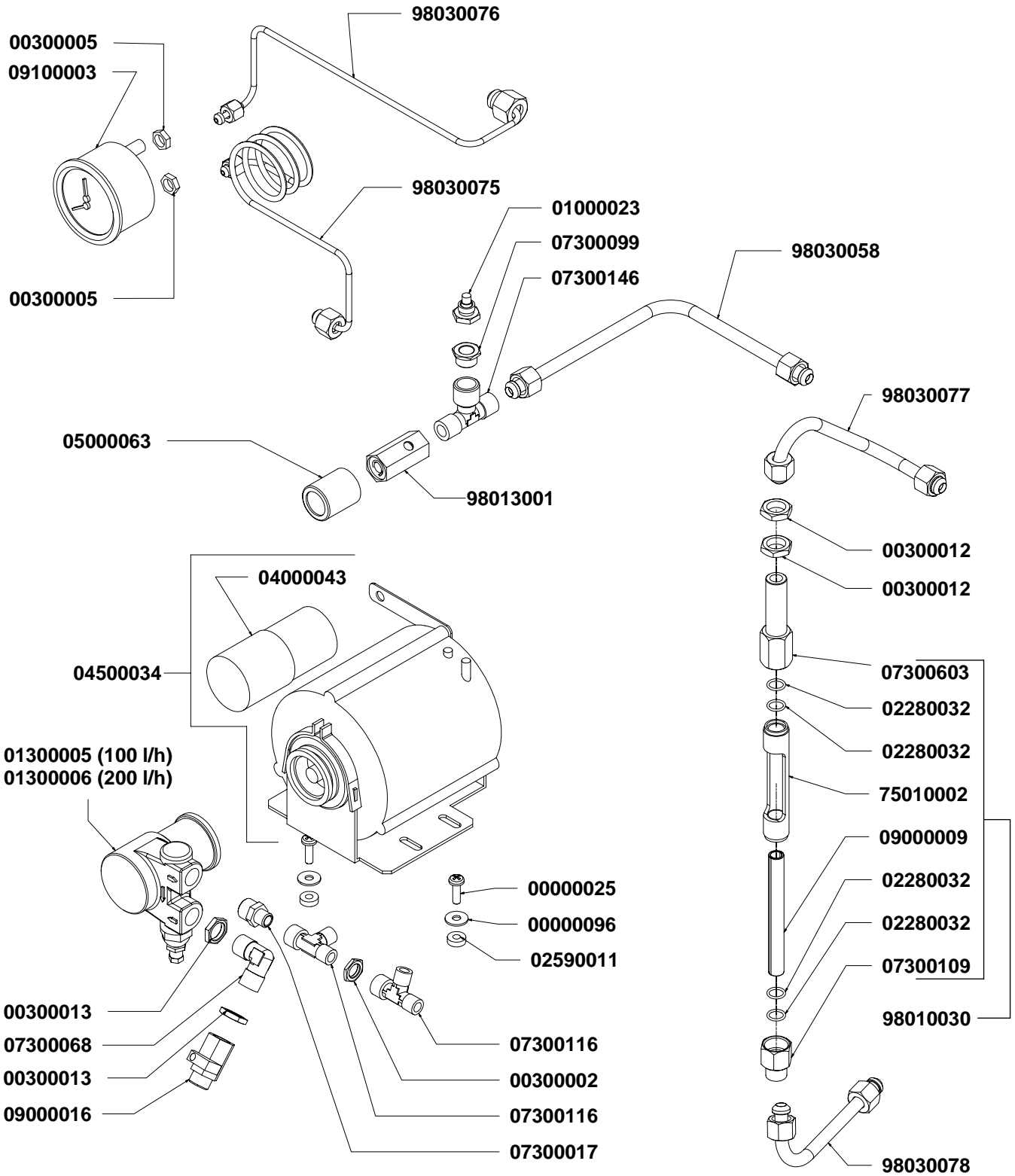

COMPONENTI IDRAULICI		
CODICE	DESCRIZIONE	DESCRIPTION
01000113	TUBO INGRESSO L=1500	FILLING TUBE L=1500
01000030	TUBO INGRESSO L=500	FILLING TUBE L=500
01000087	TUBO SCARICO	DRAINING TUBE
00000133	FASCETTA INOX	STAINLESS STEEL GIRDLE

# COMPONENTI RUBINETTI VAPORE E ACQUA CALDA STEAM & HOT WATER VALVES PARTS

A  
P  
P  
I  
A

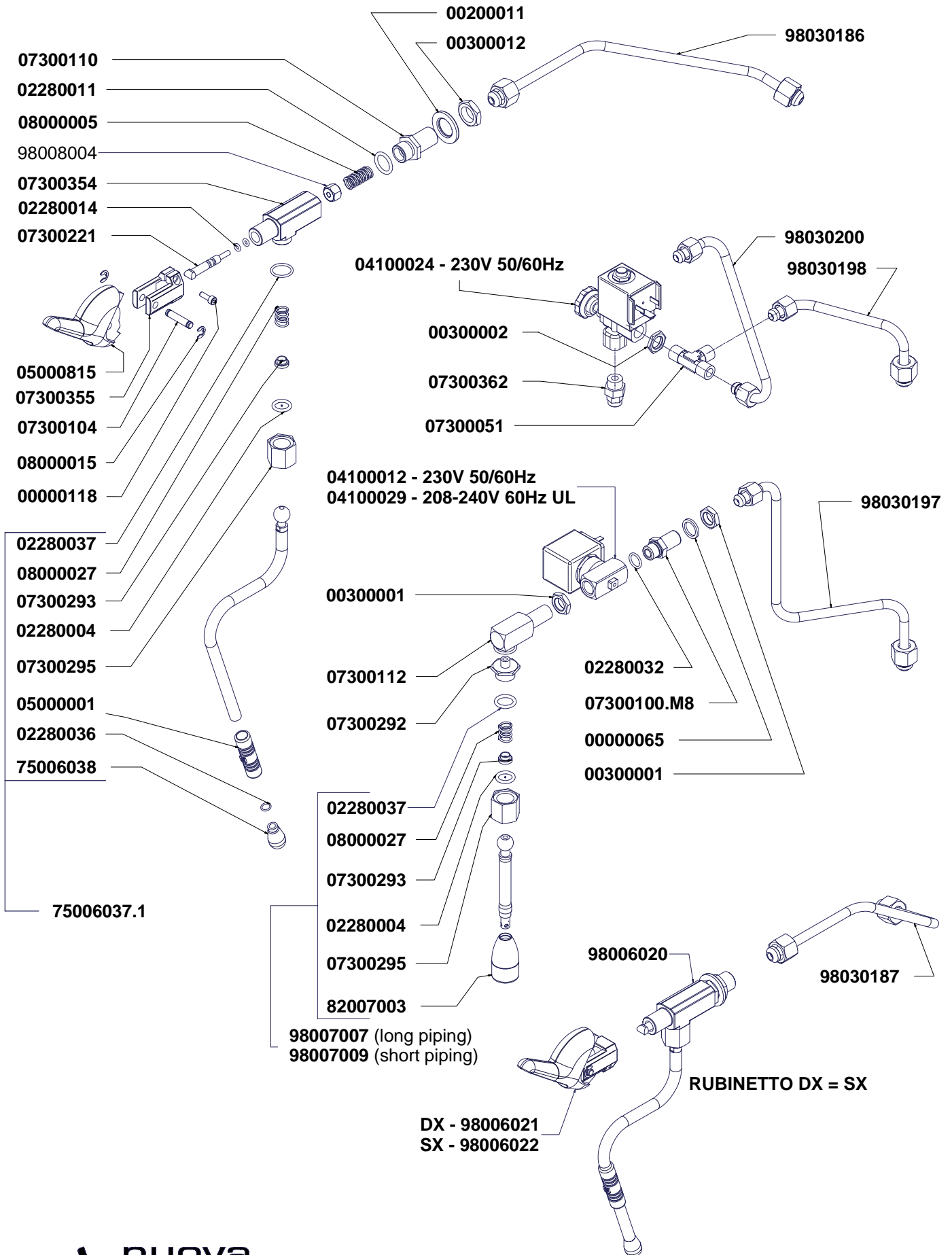



# COMPONENTI GRUPPO IDRAULICO

## HYDRAULIC GROUP PARTS

A  
P  
P  
I  
A

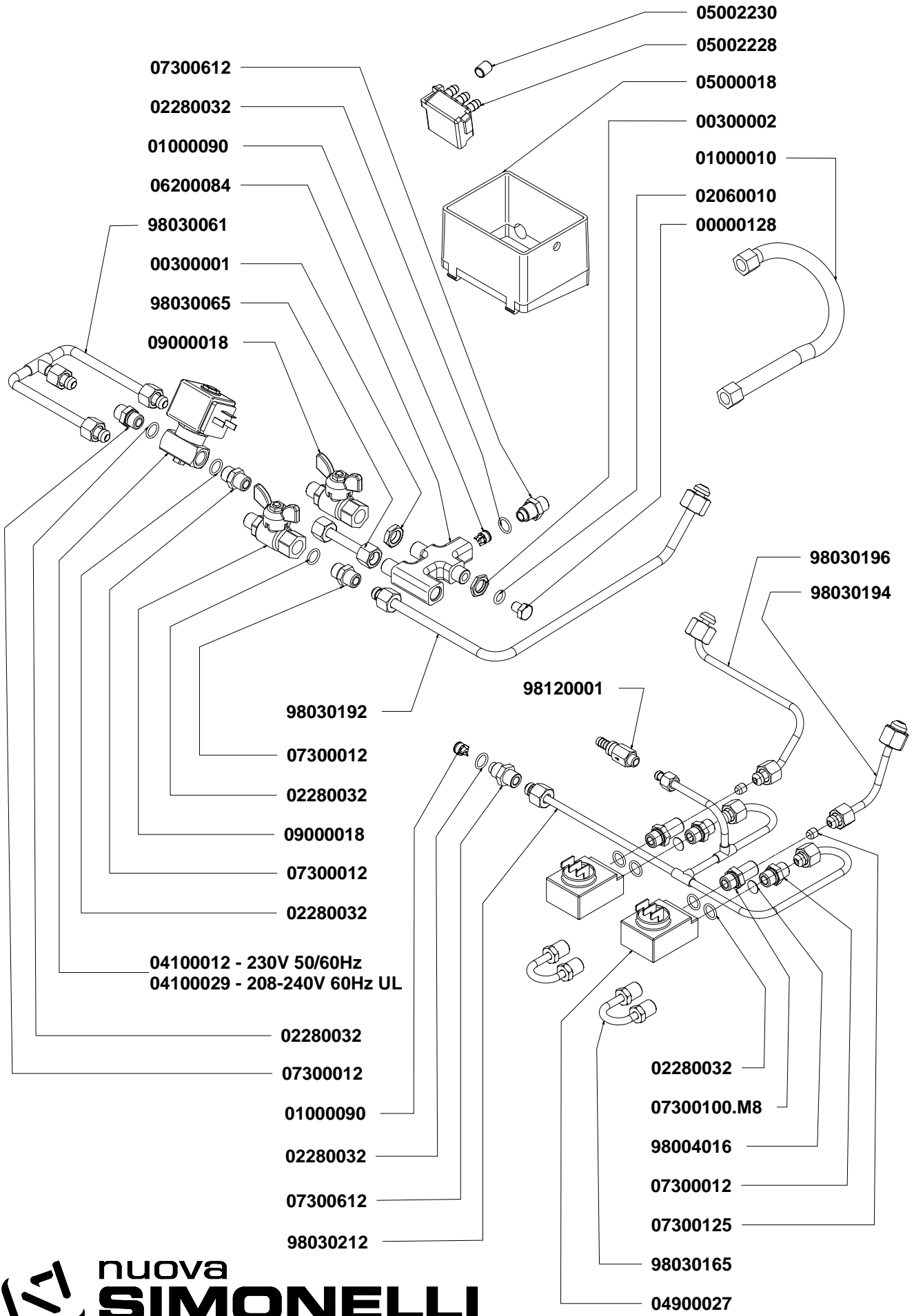

# COMPONENTI CALDAIA BOILER PARTS

A  
P  
P  
I  
A

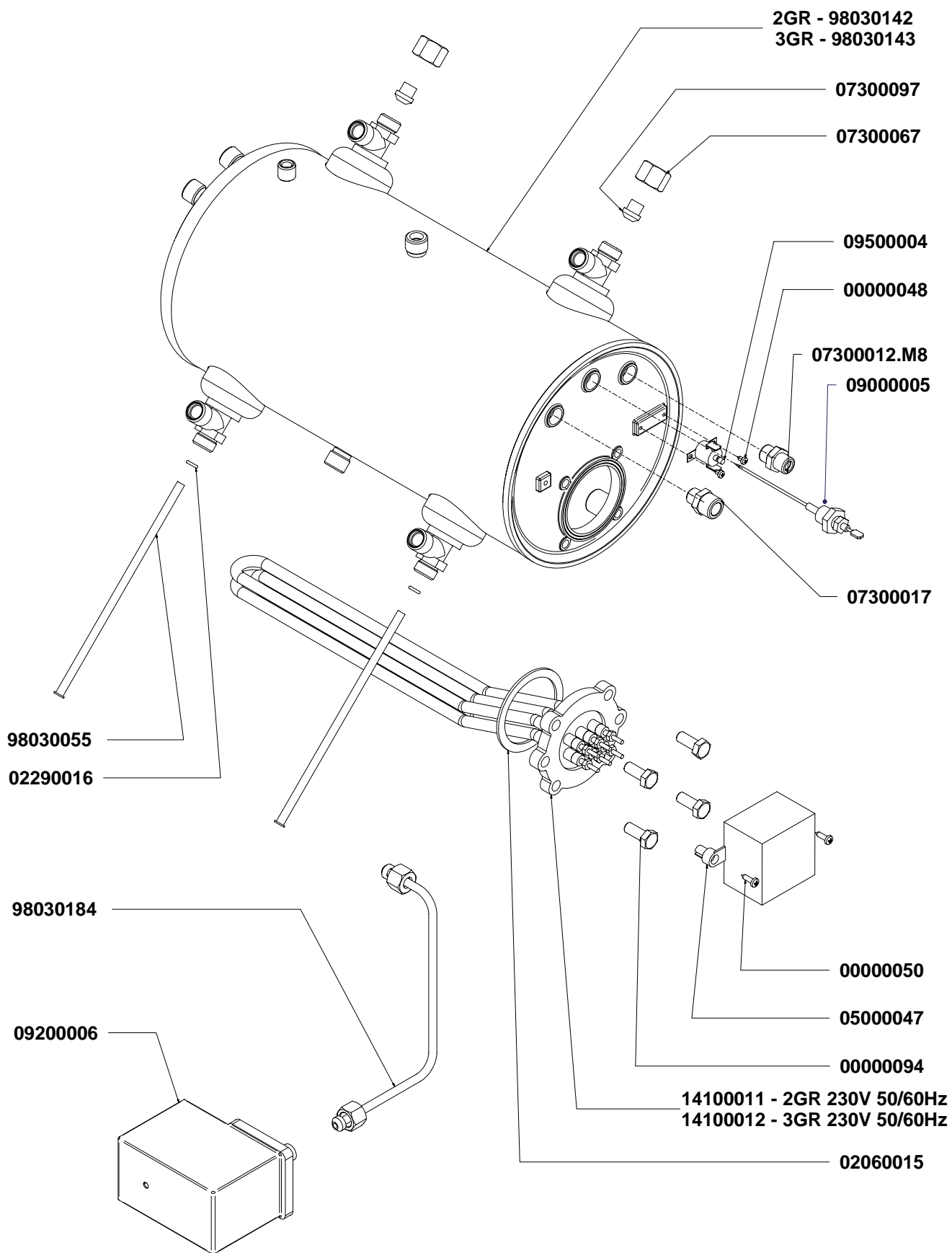

# COMPONENTI TELAIO FRAME PARTS

A  
P  
P  
I  
A

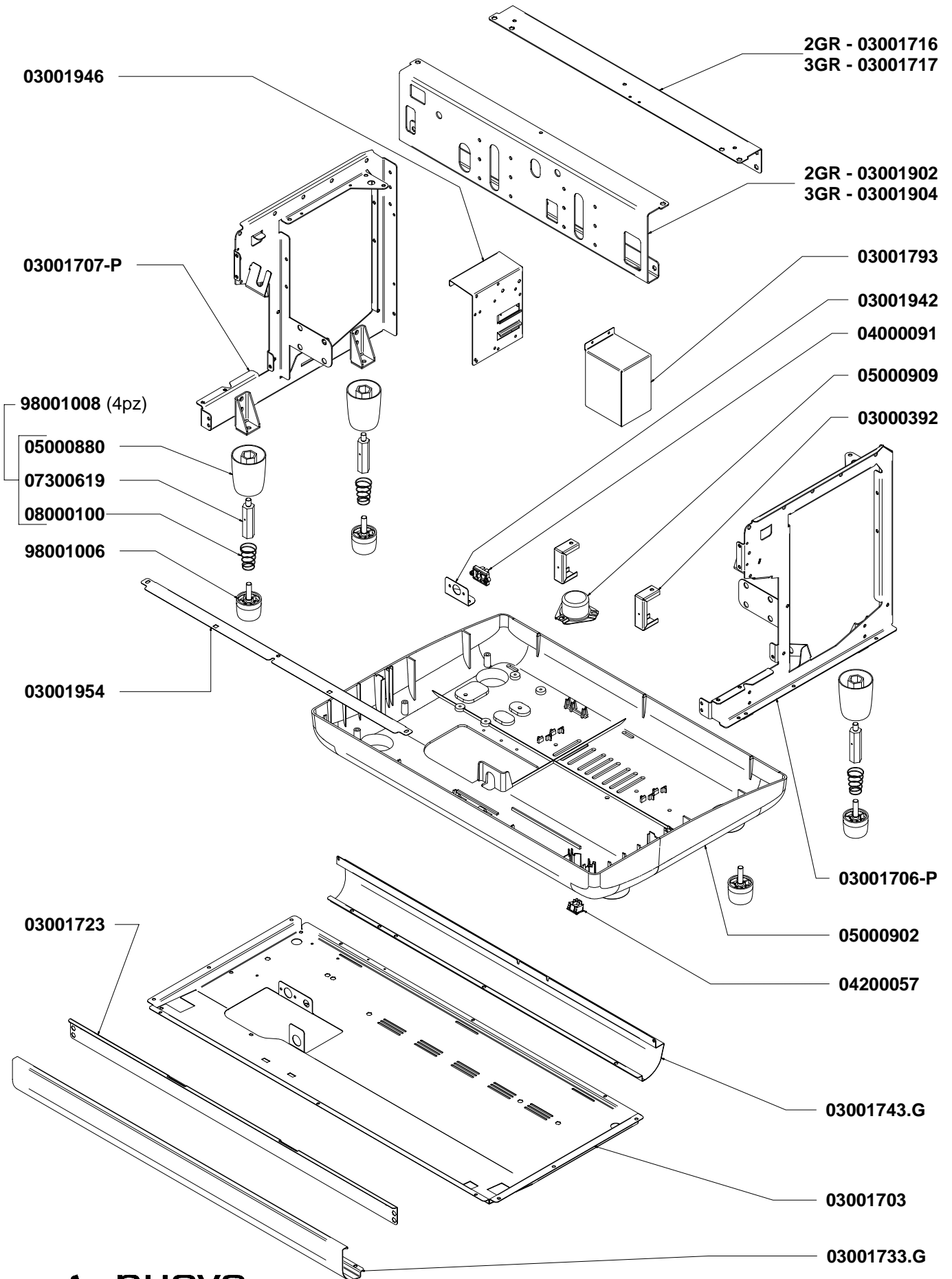

# COMPONENTI ELETTRICI ED ELETTRONICI ELECTRONIC & ELECTRIC PARTS

A  
P  
P  
I  
A

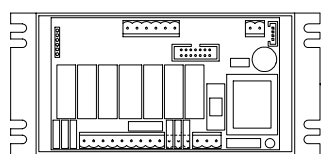

2GR - 04900732

3GR - 04900733

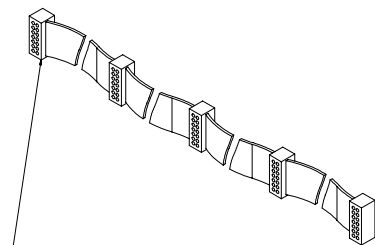
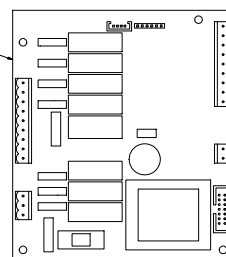

2 GR - 04000812  
3 GR - 04000813

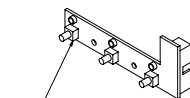

04900737

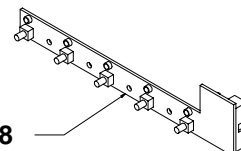

04900738

2GR - 05000919  
3GR - 05000923

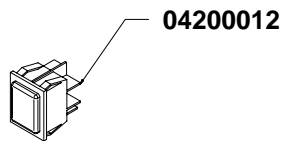
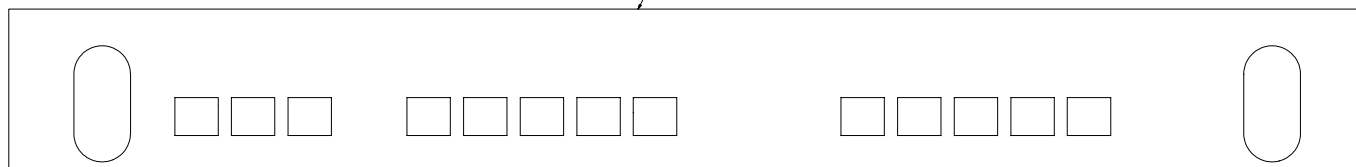

04200012

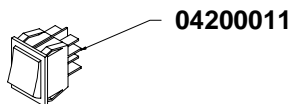

04200011

2GR - 05000921  
3GR - 05000925

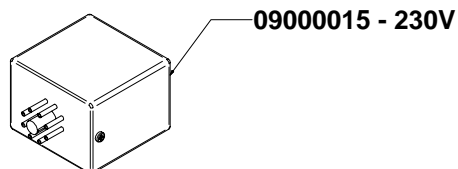

09000015 - 230V

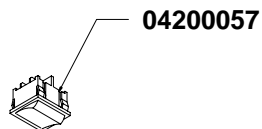

04200057

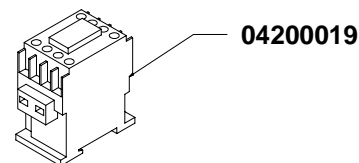

04200019

## COMPONENTI ELETTRICI

COD.	DESCRIZIONE	DESCRIPTION
04000805	IMPIANTO ELETTRICO 2GR V.	2GR VOL WIRING
04000807	IMPIANTO ELETTRICO 2GR S.	2GR SEM WIRING
04000807.P	IMP. ELET. PULSANTIERA 2GR S.	2GR SEM PUSH-BUTTON WIRING
04000808	IMPIANTO ELETTRICO 3GR V.	3GR VOL WIRING
04000809	IMPIANTO ELETTRICO 3GR S.	3GR SEM WIRING
04000809.P	IMP. ELET. PULSANTIERA 3GR S.	3GR SEM PUSH-BUTTON WIRING
04000806	IMP. ELETTRICO SCALDATAZZE	CUP WARMER WIRING

CODICE	DESCRIZIONE	DESCRIPTION	DATA FINE VALIDITA'
00000048	VITE AUTOF. 2,9X4,5 TC/T.CR.	SELF-THREADING SCREW 2.9x4.5 TC/T.CR.	
00000050	VITE AUTOF. 3,5x12 TC/T.CR.	CROSSHEAD CAP SELF-TAPPING SCREW 3,5x12	
00000065	RONDELLA OT 1/4	BRASS WASHER 1/4	
00000089	VITE INOX M4X12 TC TCR DIN7985	SS CROSS HEAD CAP SCREW M4x12	
00000094	VITE INOX M 8X20 TE 5739	STAINLESS STEEL HEX CAP SCREW M8x20	
00000118	VITE INOX M4X12 BRUGOLA 5931	SS HEX SOCKET CAP SCREW M4x12	
00000122	VITE 8.8 M6x12 TE FLAN. ZIGRI.ZINC. BIANCO	GALV. FLANGED KNURLED HEX CAP SCREW 8.8 M6x12	
00000128	VITE INOX M8x10 TE TUTTO FIL.	STAINLESS STEEL HEX CAP SCREW M8x10	
00000133	FASCETTA INOX WD12 16-25 C7 W2	STAINLESS STEEL GIRDLE WD12 16-25 C7 W2	
00000186	PRIGIONIERO M4x55 1xTC	CLOSURE STUD M4X55	
00200011	RONDELLA ZINC M16 17X30X3	GALVANISED WASHER M16 17x30x3	
00300001	DADO OT 1/4 GAS SPESSORE 5	BRASS NUT 1/4 GAS THICKNESS 5	
00300002	DADO OT 1/4 SPESS.3	BRASS NUT 1/4 THICKNESS 3	
00300005	DADO OT 1/8 GAS SPESSORE 4	BRASS NUT 1/8 GAS THICKNESS 4	
00300012	DADO OT 3/8 GAS ES 22 SPES 6	BRASS NUT 3/8 GAS THICKNESS 6 HEX 22	
00300013	DADO OT 3/8 GAS SPESS.4 mm.	BRASS NUT 3/8 GAS THICKNESS 4	
00300021	VITE INOX M6X18 TSP TC DIN963	SS SLOTTED COUNTERSUNK SCREW M6X18 DIN963	
01000010	TUBO FLESS.INOX 1/4-F.F. L.300	STAINLESS STEEL FLEXIBLE TUBE 1/4 F-F L.300	
01000023	VALVOLINA SFIATO	ANTI VACUUM VALVE	
01000030	TUBO FLESS INOX 3/8 FF 500 AL	STAINLESS STEEL FLEXIBLE TUBE 3/8 F-F L.500	
01000072	ANTIVIBRANTE AD 10x10 M4 MM	ANTI-VIBRATING AD 10X10 M4 MM	
01000083	ANTIVIBRANTE DD 10x10 M4	ANTI-VIBRATING DD 10X10 M4	
01000087	TUBO SCARICO 18x24,4	DRAINING TUBE 18x24,4	
01000090	VALVOLINA DI RITEGNO CO10	RETAINING VALVE CO10	
01000113	TUBO FLESS INOX 3/8 A 90° F. -3/8 F. L=1500	SS FLEXIBLE TUBE 3/8 90° BENDED 3/8 F-F L1500	
01300005	POMPANTE VOLUMETRICO 100 lt/h	VOLUMETRIC PUMP 100 Lt/h	
01300006	POMPANTE VOLUMETRICO 200 lt/h	VOLUMETRIC PUMP 200 Lt/h	
02060010	OR RAME 8,3x13xh1,9 DN8	COPPER GASKET O RING 8.3x13x1.9 ND8	
02060015	GUARNIZIONE PTFE 067x054x2	GASKET FOR HEATING ELEMENT 067x054x2	
02280004	GUARN. OR 115 D.17 EP856	GASKET OR 115 D17 EP851 x SWIVEL STEAM PIPE	
02280011	GUARN. OR R11 D19 EP 851	GASKET O RING R11 D19 EP 851	
02280014	GUARN. OR D 7 AN2/OR102 SILIC	GASKET O RING D.7 AN2/OR102 SILICON	
02280020.V	GUARNIZ. SOTTOCOPPA CONICA h8,2 V - NBR 82/84ShA	GROUP GASKET CONICAL	
02280032	GUARN. OR 114 D.15 EP 851	GASKET O RING 114 D.15 EP 851	
02280036	GUARN. OR x BECCO LANCIA VAP.	GASKET OR x STEAM WAND NOZZLE	
02280037	GUARN. OR CHIUSURA SNODO 16x2	GASKET OR JOINT LOCK 16x2	
02290016	GUARN. OR D 9,5 R5 SILICONE R.	GASKET OR D 9,5 R5 SILICON RED	
02590009	GUARNIZ.PISTONCINO012X4,5Xh4 *SILICONE ROSSO	PISTON GASKET 12X4,5Xh4	
02590011	GUARNIZ.PISTONCINO 14,4X6X4,5 SILICONE ROSSO	PISTON GASKET 14,4X6X4,5	
03000004	STAFFA SINGOLA x TERMOSTATO	STEEL HOLDER FASTOM FOR THERMOSTAT	
03000066	DOCCIA INOX 056X05,5X6	SHOWER INOX 056X05,5X6	
03000107	FILTRO CIECO	BLIND FILTER	
03000321	FILTRO 1 CAFFE' h=21,5 MOD.90	FILTER 1 COFFEEH=21,5 MOD.90	
03000322	FILTRO 2 CAFFE' h=21,5 MOD.90	FILTER 2 COFFEEH=21,5 MOD.90	
03000392	SUPPORTO CALDAIA MAC96	BOILER SUPPORT	
03001703	BASAMENTO PORTANTE 3GR AURELIA 3 GR. APPIA	BASE PLATE AURELIA 3 GR	
03001706-P	FIANCO DX TELAIO CON RINFORZO PIEDE SALDATO	RIGHT SIDE FRAME WITH WELDED FOOT REINFORC.	
03001707-P	FIANCO SX TELAIO CON RINFORZO PIEDE SALDATO	LEFT SIDE FRAME WITH WELDED FOOT REINFORC.	
03001716	LAMIERA L SUP. POSTERIORE 2GR	L UPPER BACK SUPPORT 2 GR.	
03001717	LAMIERA L SUP. POSTERIORE 3GR	L UPPER BACK SUPPORT 3 GR.	
03001723	LAMIERA L INF.ANTERIORE 3 GR.	L LOWER FRONT SUPPORT 3 GR.	
03001733.G	LAMIERA INF. FRONTALE 3 GR. GRIGIO ANTRACITE	CHARCOAL GRAY LOWER FRONT PANEL AURELIA 3 GR.	
03001743.G	LAMIERA INF. POSTERIORE 3 GR. GRIGIO ANTRACITE	CHARCOAL GRAY LOWER BACK PANEL AURELIA 3 GR.	
03001766	RETINA PIANO LAVORO 2 GR.	WORK GRILL 2 GR.	
03001769	SUPP. TAZZINE x AURELIA USA	AURELIA RAISED CUP STAND	
03001772	PIATTO RACCOGLIACQUA 2 GR.	DRAIN TRAY 2 GR.	
03001773	PIATTO RACCOGLIACQUA 3 GR.	DRAIN TRAY 3 GR.	
03001793	COPRI TELERUTTORE AURELIA	ELECTRONIC RELAY COVER AURELIA	
03001902	PARETE PORTAGRUPPI 2 GR. APPIA	GROUP HOLDER WALL 2 GR. APPIA	
03001904	PARETE PORTAGRUPPI 3 GR. APPIA	GROUP HOLDER WALL 3 GR. APPIA	
03001906	STAFFA C SUPPORTO GRUPPO APPIA	STIRRUP C GROUP SUPPORT APPIA	
03001908	CARENA RETRO 2 GR APPIA	BACK BOTTOM 2 GR APPIA	
03001909	CARENA RETRO 3 GR APPIA	BACK BOTTOM 3 GR APPIA	
03001911	LAMIERA FRONTALE 2 GR BASSI APPIA	FRONT PLATE 2 LOW GR. APPIA	
03001912	LAMIERA FRONTALE 2 GR ALTI APPIA	FRONT PART APPIA 2 GR. HIGH	
03001913	LAMIERA FRONTALE 3 GR BASSI APPIA	FRONT PLATE 3 LOW GR. APPIA	
03001914	LAMIERA FRONTALE 3 GR ALTI APPIA	FRONT PLATE 3 HIGH GR. APPIA	
03001916	INVOLUCRO COMANDI 2 GR APPIA	CONTROL WRAPPING 2 GR APPIA	
03001917	INVOLUCRO COMANDI 3 GR APPIA	CONTROL WRAPPING 3 GR APPIA	
03001922-C	RETINA PORTATAZZE 2 GR APPIA	CUPS HOLDER NET TRAY APPIA 2 GR.	
03001923-C	RETINA PORTATAZZE 3 GR APPIA	CUPS HOLDER NET TRAY APPIA 3 GR.	
03001926-C	SUPPORTO AL PULSANTIERA 2 GR	AL PUSH-BUTTON PANEL SUPPORT 2 GR	
03001927-C	SUPPORTO AL PULSANTIERA 3 GR	AL PUSH-BUTTON PANEL SUPPORT 3 GR	

APPILA

CODICE	DESCRIZIONE	DESCRIPTION	DATA FINE VALIDITA'
03001932	COPRIGRUPPO 2 GR BASSI APPIA	GROUP COVER 2 GR LOW APPIA	
03001933	COPRIGRUPPO 3 GR BASSI APPIA	GROUP COVER 3 GR LOW APPIA	
03001936	COPRIGRUPPO GR ALTO APPIA	HIGH GROUP COVER APPIA	
03001938	INSERTO INOX FIANCO DX APPIA	RIGHT SIDE INSERTION APPIA STAINLESS	
03001939	INSERTO INOX FIANCO SX APPIA	LEFT SIDE INSERTION APPIA STAINLESS	
03001942	LAMIERA FISSACAVO 2GR APPIA	CABLE FASTENER PLATE 2GR APPIA	
03001944	LAMIERA SUPPORTO CALDAIA APPIA	BOILER SUPPORT PLATE APPIA	
03001946	LAMIERA SUPPORTO CENTRALINA E TELERUTTORE	SWITCHBOARD SUPPORT PLATE APPIA	
03001954	LAMIERA ALLINEAMENTO BASAMENTO2GR. APPIA	BASE ALIGNMENT PLATE 2GR. APPIA	
04000029	SPINA 20A 250V 5466X	PLUG 20A 250V 5466X	
04000035	SPINA 30A 250V L630P	PLUG 30A 250V L630P	
04000036	CAVO ELETTRICO 3x12AWG SJO ETLroll of 76mt	ELECTRICAL CORD 3x12 AWG SJO ETL	
04000090	CAVO ELETTRICO FROR 5X2,5	ELECTRIC CABLE FROR 5X2,5	
04000091	FISSACAVO 4228/B	CABLE CLAMP 4228/B	
04000126	CAVO ELETTR. 2mt SPINA SCHUKO 90° 3x1,5 H05VV-F	ELECTRIC CABLE 2MT CE SCHUKO PLUG 90° 3X1,5	
04000503	CAVO ELETTRICO FROR 5 X 4	ELECTRIC CABLE FROR 5X4	
04000540	CAVO ELETTR. FROR 5x2,5 2mt 450/750V	POWER SUPPLY CABLE FROR 5x2,5 2mt	
04000541	CAVO ELETTR. FROR 3x4 2mt 450/750V	POWER SUPPLY CABLE FROR 3x4 2mt	
04000805	CABLAGGIO COM. 2 GR V APPIA	WIRING COM. 2 GR V APPIA	
04000806	CABLAGGIO SCALDATAZZE 2-3 GR. APPIA	CUPS WARMER WIRING 2-3 GR. APPIA	
04000807	CABLAGGIO COMP. 2 GR S APPIA	WIRING COMP. 2 GR S APPIA	
04000807.P	CABLAGGIO PULSANTIERA 2/3 GR APPIA S	WIRING PUSH-BUTTON PANEL 2/3 GR. APPIA S	
04000808	CABLAGGIO COMP. 3 GR V APPIA	WIRING COMP. 3 GR V APPIA	
04000809	CABLAGGIO COMP. 3 GR S APPIA	WIRING COMP. 3 GR S APPIA	
04000809.P	CABLAGGIO PULSANTIERA 3 GR. S APPIA	WIRING PUSH-BUTTON PANEL 3 GR. S APPIA	
04000810	PROTEZIONE PVC CENTRALINA APPIA	PVC SWITCHBOARD PROTECTION APPIA	
04000812	CAVO 14 VIE COLL.PULSANTIERA 2GR APPIA + GUAINA	CABLE 14 WAYS TOUCHPAD APPIA 2 GR.	
04000813	CAVO 14 VIE COLL.PULSANTIERA 3GR APPIA + GUAINA	14 WAYS CABLE CONNECT. PUSHBUTTON PANEL 3GR	
04100012	E.V. NC 2VIE 1/4-1/4 220-230V 50/60HZ VITON F1.5 CE	EV 2W 1/4 1/4 220-230V 50/60HZ VITON F1,5 CE	
04100017	E.V. NC 3VIE BAS. SCAR.1/8 230V 50/60Hz RUBY F1.5	EV 3W DOWNL.1/8 220-230V 50/60HZ RUBY F1,5 CE	
04100024	E.V. NC 2VIE 1/4 REGOLAT. 90° 230V 50/60Hz F3 CE	2 WAYS EV WITH REGULATOR	
04100027	E.V. 3VIE BAS. SCAR.1/8 208-240V 60Hz RUBY F1.3 UL	EV 3W DRAIN 1/8 208-240V 60Hz RUBY D1,3 UL	
04100029	E.V. NC 2VIE 1/4-1/4 208-240V 60Hz VITON F1.5 UL	E.V. 2VIE AL 220/240 50/60 UL	
04200011	INTERRUTTORE BIPOLARE LUMINOSO ROSSO RETTANG.	BIPOLEAR LUMINOUS SWITCH	
04200012	SEGNALATORE LUMINOSO ROSSO RETTANGOLARE	RECTANGULAR RED LUMINOUS SIGNAL SYSTEM	
04200019	CONTATTORE TETRAPOLARE 25A BOBINA 230 V UL	ELECTRONIC RELAY 25A 230V UL	
04200056	INTERRUT. ACCENSIONE DOPPIO	DOUBLE ON/OFF SWITCH	
04200057	INTERRUT. ACCENSIONE BIPOL. GRANDE 10A UL 22x19	ON/OFF SWITCH 10A UL 22x19	
04500033	MOTORE EL. 2001230V 50/60Hz 120W	PUMP MOTOR MASTER/PREMIER 2001 230V 50/60Hz	
04500034	MOTORE ELETTRICO 230V 50/60Hz165W	ELECTR. MOTOR 230 V 50/60 HZ	
04900027	DOSATORE VOLUMETRICO OTT.	FLOWMETER	
04900732	CENTRALINA ELET. 2 GR V APPIA	CONTROL BOX APPIA VOL 2 GR.	
04900733	CENTRALINA ELET. 3 GR V APPIA	ELECTR. SWITCHBOARD 3 GR V APPIA	
04900737	SCHEDA SERVIZI 2/3 GR APPIA	SERVICES CARD 2/3 GR APPIA	
04900738	SCHEDA EROG. 2/3 GR APPIA	CIRCUIT BOARD APPIA 2/3 GR	
05000001	GOMMINO PROTEZIONE LANCIA D.10	STEAM ARM RUBBER GRIP	
05000018	VASCHETTA SCARICO AURELIA	DRAIN BOX	
05000037	GHIERA FILETTATA PER PANNELLI M4 BIANCO	THREADED RING NUT FOR PANELS M4 WHITE	
05000047	COPRI RESISTENZA PROGRAM/ISX *	HEATING ELEMENT COVER	
05000063	COPRI VALVOLA SICUREZZA	SAFETY VALVE COVER	
05000079	PROTEZIONE PER VETRO LIVELLO	PROTECTION FOR LEVEL GLASS	
05000803.G	FIANCO INF. DX AURELIA GRIGIO ANTRACITE	CHARCOAL GREY RIGHT LOWER PANEL AURELIA	
05000804.G	FIANCO INF. SX AURELIA GRIGIO ANTRACITE	CHARCOAL GREY LEFT LOWER PANEL AURELIA	
05000815	MANOPOLA VAPORE AURELIA	STEAM LEVER HANDLE	
05000817	MOSTRINA MANOMETRO LIVELLO AURELIA GREZZO	MANOMETER LEVEL FRAME AURELIA RAW	
05000840	MANOPOLA PORTAFILTRO 2003 NERO	FILTER HOLDER KNOB 2003 BLACK	
05000842	CHIUSURA MANOPOLA PORTAFILTRO 2003	FILTER HOLDER KNOB LOCK 2003	
05000844	RIVESTIMENTO GOMMA NERA MANOPOLA PORTAF.	BLACK RUBBER COVER FILTER HOLDER KNOB	
05000870.T	ETICHETTA ADESIVA N.SIMONELLI 235x30	ADHESIVE LABEL N.SIMONELLI 235X30 TECHNOFLEX	
05000880	PROLUNGA PIEDE ALTO 2005 D.66 H=80 mm.	TALL FOOT EXTENSION D.66 H=80 MM.	
05000892	CHIUSURA SICUR. PIANO LAVORO 2GR ABS - INOX	SAFETY COVER 2 GR ABS - STAINLESS STEEL	
05000893	CHIUSURA SICUR. PIANO LAVORO 3GR ABS - INOX	SAFETY COVER 3 GR ABS - STAINLESS STEEL	
05000902	BASAMENTO 2 GR. APPIA	BASE FOR 2 GR. APPIA	
05000904.G	FIANCATA DX APPIA COL. GRIGIO	RIGHT SIDE APPIA GREY	
05000904.N	FIANCATA DX APPIA COL. NERO	APPIA RIGHT SIDE PANEL BLACK	
05000904.R	FIANCATA DX APPIA COL. ROSSO	SIDE PANEL APPIA RED	
05000905.G	FIANCATA SX APPIA COL. GRIGIO	LEFT SIDE APPIA GREY	
05000905.N	FIANCATA SX APPIA COL. NERO	APPIA LEFT SIDE PANEL BLACK	
05000905.R	FIANCATA SX APPIA COL. ROSSO	LEFT SIDE APPIA RED	
05000909	PROTEZIONE ABS INTERR. 2GR. APPIA	ABS SWITCH PROTECTION 2GR. APPIA	
05000912	PULSANTIERA 2 GR APPIA ABS	PUSH-BUTTON PANEL 2 GR APPIA ABS	
05000913	PULSANTIERA 3 GR APPIA ABS	PUSH-BUTTON PANEL 3 GR APPIA ABS	
05000919	PELLICOLA ADESIVA 2 GR V APPIA	ADHESIVE FILM 2 GR APPIA VOL	

A  
P  
P  
I  
A

CODICE	DESCRIZIONE	DESCRIPTION	DATA FINE VALIDITA'
05000921	PELLICOLA ADESIVA 2 GR S APPIA	ADHESIVE FILM 2 GR APPIA SEM	18/09/2007
05000923	PELLICOLA ADESIVA 3 GR V APPIA	ADHESIVE FILM 3 GR APPIA VOL	
05000925	PELLICOLA ADESIVA 3 GR S APPIA	ADHESIVE FILM 3 GR APPIA SEM	
05002228	COLLETTORE SCARICO GRUPPI EROG	POURING UNIT DRAIN MANIFOLD	
05002230	TAPPO GOMMA SCARICO x 05002228	DRAIN RUBBER PLUG	
05080035	PRESSA CAFFE' ABS MEL	PLASTIC COFFEE PRESS	
05180006	PIPETTA PORTAGOMMA 90° x POMPA	SMALL PIPE	
05340023	GRIGLIA NYLON 178x210	NYLON GRILL 178X210	
06200008	BECCO DUE VIE	TWO WAYS SPOUT	
06200029	CORPO LIVELLO PROGRAM	BODY LEVEL PROGRAM	
06200084	CROCIERA 5 VIE OTT. "AURELIA"	CROSSPIECE 5 WAYS BRASS "AURELIA"	
06200086	CORPO PORTAF. INCLINATO 2003	TILTED FILTER HOLDER BODY 2003	
07300009	DADO RACCORDO 1/4 GAS	NUT CONNECTION 1/4 GAS	
07300012.M8	RACC. 1/4 1/4 GAS CON OR F.M8	CONNECTION 1/4 1/4 W/OR HOLE M8	
07300017	RACCORDO 1/4 3/8 GAS OT.	FITTING 1/4 3/8 GAS OT.	
07300034	PISTONCINO 12x4,5x4	VALVE PISTON 12x4,5x4	
07300051	RACCORDO T 1/4 M-M-M CILIN 464	CONNECTION T 1/4 M-M-M CYLIN 464	
07300052	PISTONCINO 014X06X4.5 VALV SICUREZZA	SMALL PISTON 014X06X4.5 SAFETY VALVE	
07300053	CORPO VALVOLA SICUREZZA	SAFETY VALVE BODY	
07300063	TERMINALE D 11 CHIUSO	TERMINAL D 11 CLOSED	
07300067	DADO RACCORDO 3/8 GAS D11	NUT CONNECTION 3/8 GAS D11	
07300068	RACCORDO L 3/8 M-M CILIN 459	CONNECTION L 3/8 M-M CYLIN 459	
07300092	BECCO UNA VIA CURVO	SINGLE SPOUT	
07300097	TERMINALE CHIUSO D 14	TERMINAL D.14	
07300099	RIDUZIONE 3/8 1/4 ES. 20	VACUUM RELIEF VALVE ADAPTER	
07300100.M8	ATTACCO SCARICO 1/4 VAS. SCAR.CON OR + INT. M8	DOWNLOAD FASTENING 1/4 DOWNLOAD TRAY WITH OR	
07300104	SPINOTTO RUB.VAPORE PR.	VALVE SHAFT VALVE SHAFT	
07300109	PREMISTOPPA LIVELLO PROGRAM	GLAND LEVEL PROGRAM	
07300110	TAPPO PORTA MOLLA R.V. PR.	SPRING HOLDER TAP	
07300112	ATTACCO RUB. ACQUA PROGRAM	FASTENING WATER PROGRAM TAP	
07300116	RACCORDO T 1/4 M-M-F	JOINT T1/4 M-M-F 465	
07300125	GIGLER M8X8 F.0.8 AG.28.05.93*	GIGLEUR M8X8 F.0.8	
07300127	GIGLER M8X8 F.2.5 AG.28.05.93<	GIGLEUR M8X8 F.2,5	
07300128	TAPPO 1/4 GAS	CAP 1/4 GAS	
07300130	TAPPO 3/8" GAS ES 17 <	PLUG 3/8" GAS ES 17	
07300146	RACCORDO A T 3/8 M-F-M 463	CONNECTION A T 3/8 M-F-M 463	
07300170	PROLUNGA FISSAGGIO FRONTALE	FRONT FIXING EXTENSION PREMIER/MASTER	
07300171	TAPPO OT M20X1,5 GR. EROG.	TAPPO OT M20X1,5 GR. EROG. CAP	
07300172	RACCORDO 3/8"M-3/8"M INT M8	PIPE FITTING 3/8"M-3/8"M INT M8	
07300177	INSERTO FILETTATO M6-M9 L=12	THREADED INSERTION M6-M9 L=12	
07300183.5	PADIGLIONE GRUPPO PREMIER2002 h=5	DIFFUSER h=5	
07300196	PERNO M4 FIX CARENA ES 6	HINGE M4 FIX BOTTOM ES 6	
07300221	ASTA INOX RUBINETTO VAP. PRO97	STEAM VALVE INOX SCREW	
07300225	GIGLER M8X8 F.3 AG.28.05.93	GIGLEUR M8X8 F.3	
07300226	GIGLER M8X8 F.2	GIGLEUR M8X8 F.2	
07300292	ATTACCO RUBINETTO X LANCIA VAP. SNODATA INOX	TAP FASTENING FOR FLEX. STAINLESS STEAM WAND	
07300293	BUSSOLA SNODO OT. AG.25.06.96	BRASS BUSHING	
07300295	DADO RACC. 3/8 LANCIA SNOD.	NUT	
07300341	PERNO BLOCCAGGIO CENTRAL. VIP NICHELATO	CENTRAL LOCK VIP NICKEL PLATED L=35	
07300342	PERNO SUPPORTO CENTRAL. VIP NICHELATO	NICKEL PLATED CONTROL UNIT SUPPORT PIN	
07300354	CORPO RUB. VAPORE x LANC. SNO.	STEAM KNOB BODY X FLEXIBLE WAND	
07300355	FORCELLA RUBINETTO '99	TAP FORK	
07300361	RACCORDO L GIR 6 1/4 VITON346A	PIVOTING CONNECTION L 6 1/4 VITON346A	
07300362	RACCORDO DIR.M.C.6 1/4 340	STRAIGHT FITTING 1/4	
07300366	RACCORDO T 1/4 F-M-F 462	CONNECTION T 1/4 F-M-F 462	
07300382	RACCORDO DIR. F 1/4 - CALZAM.	CONNECTION DIR. F 1/4 ACTUATOR	
07300601	INSERTO MANOPOLA PORTAFILTRO 2003 INOX	FILTER HOLDER KNOB INSERTION 2003 STAINLESS	
07300603	RACCORDO SUP. LIVELLO AURELIA	UPPER LEVEL CONNECTION AURELIA	
07300607	PERNO FISSAGGIO CARENE M6-L.2 NICHELATO APPIA	FIXING HINGE M6 L.2	
07300612	RACCORDO 1/4 1/4 GAS CON OR	CONNECT. 1/4 1/4 GAS WITH OR + VALVE LOCK	
07300619	INSERTO PROLUNGA PIEDE ALTO ES 20 L=70 + M10	INSERTION EXTENSION TALL FOOT ES 20 L=70 M10	
08000005	MOLLA 6 ST 11,5X8,5X25 RUB.VAPORE	STEAM VALVE SPRING	
08000007	MOLLA 011,5X8,4X32 ST9,5 RUB ENTRATA/VALV SICUR.	SPRING 011,5X8,4X32 INLET TAP/SAFETY VALVE	
08000015	ANELLO SEEGER TIPO RS 5 INOX UNI 7434	SEEGER RING RS 5 STAINLESS STEEL	
08000017	MOLLA BLOCCA FILTRO ACC.INOX	FILTER HOLDER SPRING INOX	
08000027	MOLLA PER LANCIA SNODATA	WAND SPRING	
08000031	MOLLA A PIASTRA PL2813	MOLLA A PIASTRA PL2315 REPLACE 08000020	
08000034	FASCETTA STRINGITUBO D12	HOSE CLAMPS D12	
08000059	MOLLETTE FISSAGGIO SCALDATAZZE	CUPS WARMER FIXING CLAMPS REF.210008-5 YELLOW	
08000100	MOLLA INTERNA PIEDE 2005	FOOT INNER SPRING 2005	
09000005	SONDA AUTOLIVELLO COMPLETA L=130	WATER LEVEL SENSOR	
09000009	VETRO LIVELLO 112x12x1,5	SIGHT GLASS	
09000015	CENTRALINA AUTOLIVELLO 230V	AUTO WATER FILL CIRCUI 230V	

A  
P  
P  
I  
A

CODICE	DESCRIZIONE	DESCRIPTION	DATA FINE VALIDITA'
09000016	RUBINET.ALLACCIO RETE 3/8 M-F	TAP CONNECTION SUPPLY 3/8 M-F	
09000018	RUBINET.DISTRIBUTORE 1/4 M-F	DISPENSER TAP 1/4 M-F	
09100003	MANOMETRO DOPPIA SCALA	DOUBLE SCALE GAUGE	
09200006	PRESSOSTATO MACCHINA	PRESSOSTAT	
09500004	TERMOSTATO R.MAN. 135°C	AUTOMATIC THERMOSTAT 135°C	
09500006	TERMOSTATO R.AUT. 55°C	THERMOSTAT 261 R.AUT. 55 C	
11600004	TUBO SILICONE 5x9 60Sh PEROX BIANCO	SILICON PIPE WHITE 5x9 60Sh SEMI-TRANSPARENT	
11740001	TUBO TEFLON 6/4	TEFLON PIPE 4X6	
14100011	RESISTENZA 3000W PR/ 2 GR. #	HEATING ELEMENT 3000W	
14100012	RESISTENZA 5000W PR/3-4 GR. #	HEATING ELEM. 5000W	
14100045	RESISTENZA SCALDATAZZE 2 GR. 230V 150W L.506	CUPS WARMER RESISTOR 2 GR. 230V 150W L.506	
14100046	RESISTENZA SCALDATAZZE 3 GR. 230V 150W L.736	CUPS WARMER RESISTOR 3 GR. 230V 150W L.736	
40000010	DADO M6 CON RONDELLA SALDATA ZINCATO	NUT M6 WITH WELD ZINCKED WASHER	
75006037.1	KIT LANCIA VAPORE SNODATA INOX INCLINATA	SWIWEL STEAM WAND KIT	
75006038	BECCO VAPORE M8,65x0,75 F. 1,5	STEAM TIP	
75010002	CORPO LIVELLO LAVORATO E CROMATO	METAL CASING FOR SIGHT GLASS	
78004001	GRUPPO EROG. LAV. E CROMATO PREMIER/MAC/APPIA	GROUP HEAD	
82007003	ROMPIGETTO ACQUA CALDA D.23,5	HOT WATER DISPERSION NUT D.23,5	
98001006	PIEDE MACCHINA 06 BICOMPONENTE	MACHINE FEET	
98001008	KIT PIEDI ALTI 2006 (4 pz.)	KIT TALL FEET 2006 (4 PCS.)	
98004001	FILTRO INOX DIAM. 8	FILTER INOX DIAM. 8	
98004016	FILTRO INOX DIAM. 12	STAINLESS FILTER DIAM. 12	
98005021	PORTAFILTRO INCLINATO COMP. 1	COMPLETE ERGONOMIC FILTERHOLDE1 SPOUT	
98005022	PORTAFILTRO INCLINATO COMP. 2	COMPLETE FILTERHOLDER 2 WAYS ERGONOMIC	
98005024	CORPO PORTAFILTRO INCLINATO + MANOPOLA	TILTED FILTERHOLDER +HANDLE	
98005026	KIT MANOPOLA PORTAFILTRO 2004	FILTERHOLDER HANDLE KIT	
98006020	RUBINETTO VAPORE +LANCIA INOX AURELIA	STEAM TAP +WAND STAINLESS AURELIA	
98006021	ASSIEME MANOPOLA VAPORE "2004" DX	COMBINED STEAM KNOB "2004" RIGHT	
98006022	ASSIEME MANOPOLA VAPORE "2004" SX	COMBINED STEAM KNOB "2004" LEFT	
98007007	KIT LANCIA ACQUA C. INOX L=100SENZA ROMPIGETTO	KIT HOT WATER SS WAND L=100 WITHOUT SPRAYEND	
98007009	KIT LANCIA ACQUA C. INOX L=70 COMP. DI ROMPIGETTO	KIT HOT WATER STAINLESS WAND L=70 W/SPRAYEND	
98008004	PISTONCINO CHIUSURA COMPLETO	COMPLETE STEAM VALVE PISTON	
980100000000100000	FIANCATA APPIA DX COMPLETA	COMPLETE RIGHT SIDE APPIA	
980100000000120000	FIANCATA APPIA SX COMPLETA	COMPLETE LEFT SIDE APPIA	
98013001	VALVOLA DI SICUREZZA COMPLETA	COMPLETE SAFETY VALVE	
98013002	PISTONCINO VALV.SICUREZ.COMPL.	SMALL PISTON COMPL. SAFETY VALVE	
980300000000020000	ASSIEME CALDAIA COMP. 2 GR. APPIA	COMBINED BOILER COMP.2 GR. APPIA	
980300000000030000	ASSIEME CALDAIA COMP. 3 GR. APPIA	COMBINED BOILER COMP.3 GR. APPIA	
98030055	TUBO TEFLON INT. SCAMBIATORE D.6 x 180 mm.	INT. TEFLON TUBE EXCHANGER D.6 X 180 MM.	
98030061	CROCIERA RUBIN. + EV. LIVELLO AURELIA	CROSSPIECE TAP + EV. LEVEL AURELIA	
98030065	TUBO D.8 1/4 1/4 L=50	TUBE D.8 1/4 1/4 L=50	
98030075	TUBO CAPILLARE 1/8-1/4 0,9x2x400 MANOMETRO-POMPA	CAPILLARY TUBE 1/8-1/4 0,9X2X400 MANOM.-PUMP	
98030078	TUBO 3/8 3/8 LIVELLO INF.	TUBE 3/8 3/8 LOWER LEVEL	
98030142	CALDAIA SALDATA 2 GR. APPIA D.180	WELD BOILER APPIA 2 GR. D.180	
98030143	CALDAIA SALDATA 3 GR. APPIA D.180	WELD BOILER APPIA 3 GR. D.180	
98030165	TUBO 1/4 1/4 MODIFICA SEMIAUT APPIA 1-2-3 GR.	TUBE 1/4 1/4 SEM CHANGE APPIA 1-2-3 GR	
98030182	TUBO 3/8-3/8 LIVELLO SUP. APPIA 2-3 GR.	TUBE 3/8-3/8 UPPER LEVEL APPIA 2-3 GR.	
98030184	TUBO 1/4-1/4 CALDAIA-PRESSOST.APPIA 2-3 GR.	TUBE 1/4-1/4 BOILER-PRESSOST. APPIA 2-3 GR.	
98030186	TUBO 3/8-3/8 CALDAIA-R.VAP.SX APPIA 2-3 GR.	TUBE 3/8-3/8 BOILER- LEFT STEAM TAP 2-3 GR.	
98030187	TUBO 3/8-3/8 CALDAIA-R.VAP.DX APPIA 2-3 GR.	TUBE 3/8-3/8 BOILER-RIGHT STEAM TAP 2-3 GR.	
98030188	TUBO 3/8-3/8 VALVOLA SICUREZZA APPIA 2-3 GR.	TUBE 3/8-3/8 SAFETY VALVE APPIA 2-3 GR.	
98030190	TUBO 1/4 1/8 CALDAIA MANOMETRO APPIA 2-3 GR.	TUBE 1/4 1/8 BOILER MANOMETER APPIA 2-3 GR.	
98030192	TUBO 3/8 1/4 CARICO CALDAIA APPIA 2-3 GR.	TUBE 3/8 1/4 LOADING BOILER APPIA 2-3 GR.	
98030194	TUBO 3/8 1/4 DOSATORE SCAMB.DX APPIA 2.3 GR.	TUBE 3/8 1/4 RIGHT DOSER EXCHANGER APPIA 2-3GR	
98030196	TUBO 3/8 1/4 DOSATORE SCAMB.SX APPIA 2-3 GR.	TUBE 3/8 1/4 LEFT DOSER EXCHANGER APPIA 2-3GR	
98030197	TUBO 3/8 1/4 CALDAIA-EV A.CAL.APPIA 2-3 GR.	TUBE 3/8 1/4 BOILER-HOT WATER EV APPIA 2-3 GR	
98030198	TUBO 3/8 1/4 CALDAIA EV MISC. A.CALDA APPIA 2-3 GR.	TUBE 3/8 1/4 BOILER-H.W. MIXER EV APPIA 2-3 GR	
98030200	TUBO 1/4 1/4 EV MISCEL.-EV A.CAPPIA 2-3 GR.	TUBE 1/4 1/4 EV MIXER-EV H WATER APPIA 2-3GR	
98030202	TUBO SUP. 3/8 3/8 GR.BASSO APPIA 2-3 GR.	TUBE SUP. 3/8 3/8 LOW GR. APPIA 2-3 GR.	
98030204	TUBO INF. 3/8 3/8 GR.BASSO APPIA 2-3 GR.	LOWER TUBE 3/8 3/8 LOW GR. APPIA 2-3 GR	
98030206	TUBO SUP. 3/8 3/8 GR. ALTO APPIA 2-3 GR.	PIPE APPIA 2-3 GR.	
98030208	TUBO INF. 3/8 3/8 GR.ALTO APPIA 2-3 GR.	INF. PIPE APPIA 2-3 GR. HIGH	
98030212	CROCIERA COLL. 2 GR. APPIA	CROSSPIECE CONNECTION 2 GR. APPIA	
98030213	CROCIERA COLL. 3 GR. APPIA	CROSSPIECE CONNECTION 3 GR. APPIA	
98030217	TUBO SILICONE D.9 SCARICO GR. DX APPIA 2 GR.	SILICON TUBE D.9 RIGHT GR. DOWNLOAD APPIA 2 GR	
98030218	TUBO SILICONE D.9 SCARICO GR. SX APPIA 2 GR.	SILICON TUBE D.9 LEFT GR. DOWNLOAD APPIA 2 GR	
98030219	TUBO SILICONE D.9 SCARICO GR. DX APPIA 3 GR.	SILICON TUBE D.9 RIGHT GR. DOWNLOAD APPIA 3 GR	
98030231	ASSIEME DOSATORE SX APPIA	COMBINED LEFT DOSER APPIA	
98030232	ASSIEME DOSATORE DX APPIA	COMBINED RIGHT DOSER APPIA	
980400000000020000	ASSIEME GRUPPO EROG. 2/3 GR. APPIA	COMBINED BREWING GROUP APPIA 2-3 GR.	
98120001	VALVOLA NEPLAX VITON 16BAR	NEPLAX VITON 16BAR VALVE 1/8 HOSE CLAMP	

A  
P  
P  
I  
A